

NTD5406N

Power MOSFET

40 V, 70 A, Single N-Channel, DPAK



ON Semiconductor®

<http://onsemi.com>

Features

- Low $R_{DS(on)}$
- High Current Capability
- Low Gate Charge
- These are Pb-Free Devices

Applications

- Electronic Brake Systems
- Electronic Power Steering
- Bridge Circuits

$V_{(BR)DSS}$	$R_{DS(ON)}$ TYP	I_D MAX (Note 1)
40 V	8.7 mΩ @ 10 V	70 A

MAXIMUM RATINGS ($T_J = 25^\circ\text{C}$ unless otherwise stated)

Parameter		Symbol	Value	Units	
Drain-to-Source Voltage		V_{DSS}	40	V	
Gate-to-Source Voltage		V_{GS}	± 20	V	
Continuous Drain Current – $R_{\theta JC}$ (Note 1)	Steady State	I_D	$T_C = 25^\circ\text{C}$	70	A
			$T_C = 125^\circ\text{C}$	40	
Power Dissipation – $R_{\theta JC}$ (Note 1)	Steady State	P_D	100	W	
Pulsed Drain Current		$t_p = 10 \mu\text{s}$	I_{DM}	150	A
Operating Junction and Storage Temperature		T_J, T_{STG}	-55 to 175	$^\circ\text{C}$	
Source Current (Body Diode) Pulsed		I_S	63.5	A	
Single Pulse Drain-to-Source Avalanche Energy – ($V_{DD} = 50 \text{ V}, V_{GS} = 10 \text{ V}, I_{PK} = 30 \text{ A}, L = 1 \text{ mH}, R_G = 25 \Omega$)		EAS	450	mJ	
Lead Temperature for Soldering Purposes (1/8" from case for 10 s)		T_L	260	$^\circ\text{C}$	

Stresses exceeding Maximum Ratings may damage the device. Maximum Ratings are stress ratings only. Functional operation above the Recommended Operating Conditions is not implied. Extended exposure to stresses above the Recommended Operating Conditions may affect device reliability.

THERMAL RESISTANCE RATINGS (Note 1)

Parameter	Symbol	Max	Units
Junction-to-Case (Drain)	$R_{\theta JC}$	1.5	$^\circ\text{C/W}$

1. Surface mounted on FR4 board using 1 in sq pad size (Cu area = 1.127 in sq [1 oz] including traces).

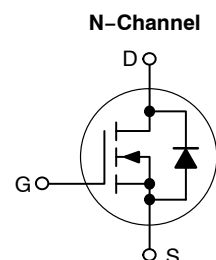

MARKING DIAGRAM

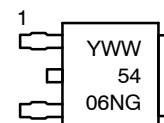

Y = Year
WW = Work Week
5406N = Specific Device Code
G = Pb-Free Device

ORDERING INFORMATION

Device	Package	Shipping†
NTD5406NG	DPAK (Pb-Free)	75 Units / Rail
NTD5406NT4G	DPAK (Pb-Free)	2500 / Tape & Reel

†For information on tape and reel specifications, including part orientation and tape sizes, please refer to our Tape and Reel Packaging Specifications Brochure, BRD8011/D.

NTD5406N

ELECTRICAL CHARACTERISTICS (T_J = 25°C unless otherwise stated)

Parameter	Symbol	Test Condition	Min	Typ	Max	Unit
OFF CHARACTERISTICS						
Drain-to-Source Breakdown Voltage	V _{(BR)DSS}	V _{GS} = 0 V, I _D = 250 μA	40			V
Drain-to-Source Breakdown Voltage Temperature Coefficient	V _{(BR)DSS} /T _J			42		mV/°C
Zero Gate Voltage Drain Current	I _{DSS}	V _{GS} = 0 V, V _{DS} = 40 V	T _J = 25°C		1.0	μA
			T _J = 100°C		10	
Gate-to-Source Leakage Current	I _{GSS}	V _{DS} = 0 V, V _{GS} = ±30 V			±100	nA

ON CHARACTERISTICS (Note 2)

Gate Threshold Voltage	V _{GS(TH)}	V _{GS} = V _{DS} , I _D = 250 μA	1.5		3.5	V
Gate Threshold Temperature Coefficient	V _{GS(TH)} /T _J			-7.0		mV/°C
Drain-to-Source On Resistance	R _{DS(on)}	V _{GS} = 10 V, I _D = 30 A		8.7	10	mΩ
		V _{GS} = 5.0 V, I _D = 10 A		13.2	17	
Forward Transconductance	g _{FS}	V _{GS} = 10 V, I _D = 10 A		19		S

CHARGES AND CAPACITANCES

Input Capacitance	C _{ISS}	V _{GS} = 0 V, f = 1.0 MHz, V _{DS} = 32 V		1375	2500	pF
Output Capacitance	C _{OSS}			370	700	
Reverse Transfer Capacitance	C _{RSS}			160	300	
Total Gate Charge	Q _{G(TOT)}	V _{GS} = 10 V, V _{DS} = 32 V, I _D = 30 A		45		nC
Threshold Gate Charge	Q _{G(TH)}			2.0		
Gate-to-Source Charge	Q _{GS}			5.4		
Gate-to-Drain Charge	Q _{GD}			20		

SWITCHING CHARACTERISTICS, V_{GS} = 10 V (Note 3)

Turn-On Delay Time	t _{d(ON)}	V _{GS} = 10 V, V _{DD} = 32 V, I _D = 30 A, R _G = 2.5 Ω		7.2		ns
Rise Time	t _r			57		
Turn-Off Delay Time	t _{d(OFF)}			30		
Fall Time	t _f			67		

SWITCHING CHARACTERISTICS, V_{GS} = 5 V (Note 3)

Turn-On Delay Time	t _{d(ON)}	V _{GS} = 5.0 V, V _{DD} = 20 V, I _D = 30 A, R _G = 2.5 Ω		15		ns
Rise Time	t _r			147		
Turn-Off Delay Time	t _{d(OFF)}			20		
Fall Time	t _f			29		

DRAIN-SOURCE DIODE CHARACTERISTICS

Forward Diode Voltage	V _{SD}	V _{GS} = 0 V, I _S = 10 A	T _J = 25°C		0.82	1.1	V
			T _J = 125°C		0.67		
Reverse Recovery Time	t _{RR}	V _{GS} = 0 V, dI _{SD} /dt = 100 A/μs, I _S = 10 A		46		ns	
Charge Time	t _a			24			
Discharge Time	t _b			22			
Reverse Recovery Charge	Q _{RR}			65			nC

- Pulse Test: pulse width ≤ 300 μs, duty cycle ≤ 2%.
- Switching characteristics are independent of operating junction temperatures.

TYPICAL PERFORMANCE CURVES

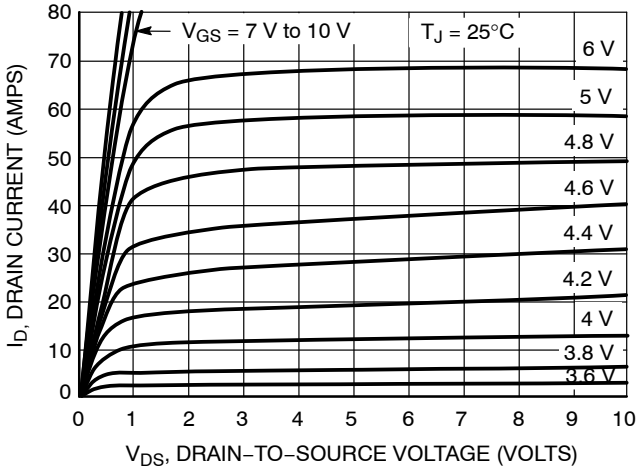

Figure 1. On-Region Characteristics

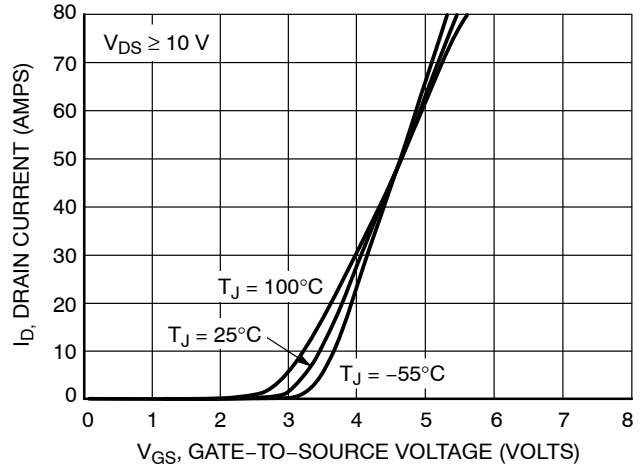

Figure 2. Transfer Characteristics

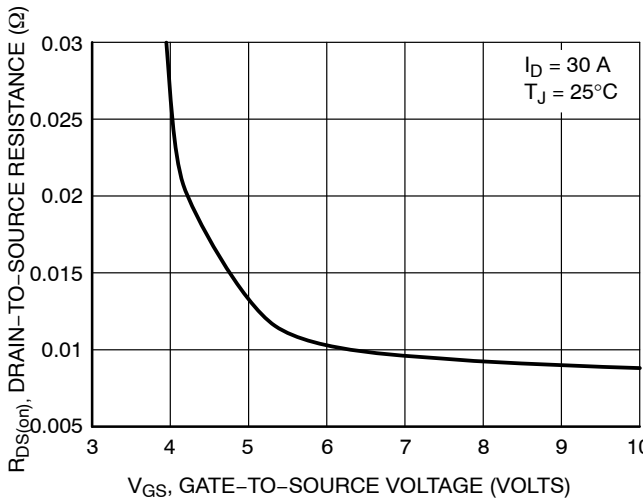

Figure 3. On-Resistance vs. Gate-to-Source Voltage

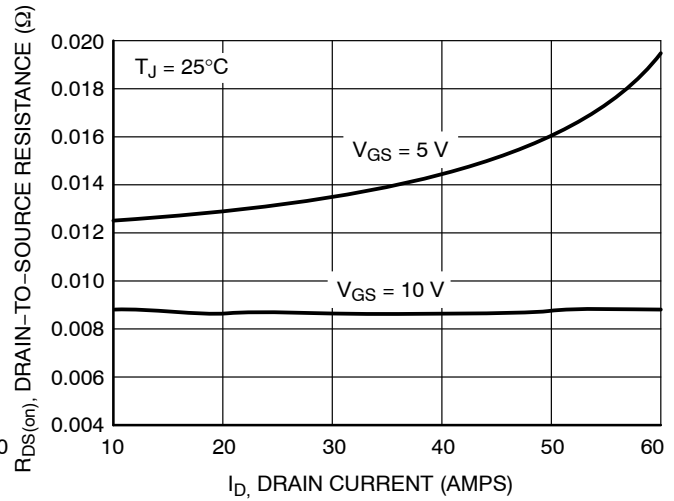

Figure 4. On-Resistance vs. Drain Current and Gate Voltage

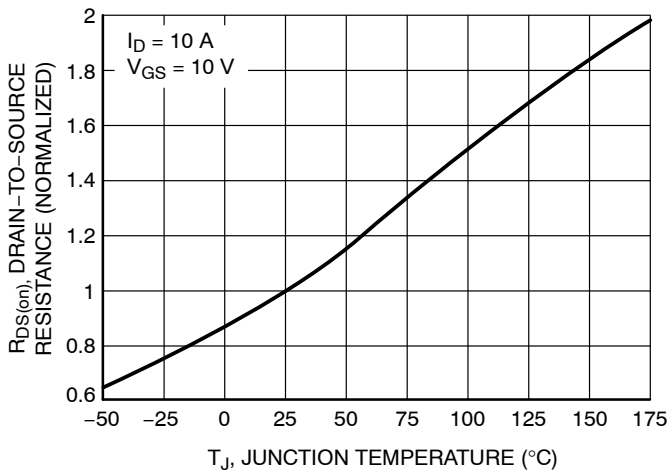

Figure 5. On-Resistance Variation with Temperature

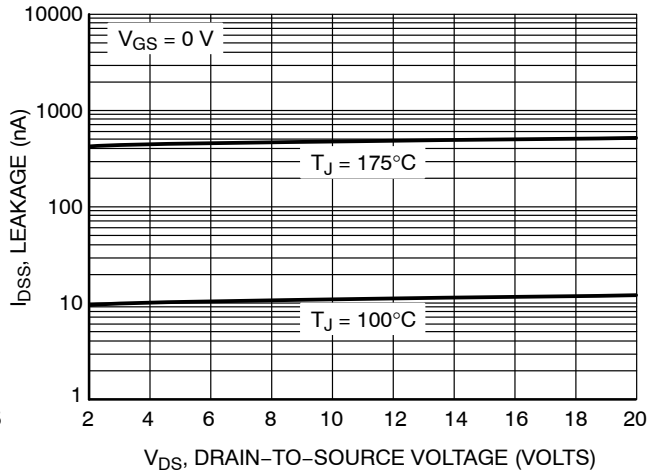

Figure 6. Drain-to-Source Leakage Current vs. Voltage

NTD5406N

TYPICAL PERFORMANCE CURVES

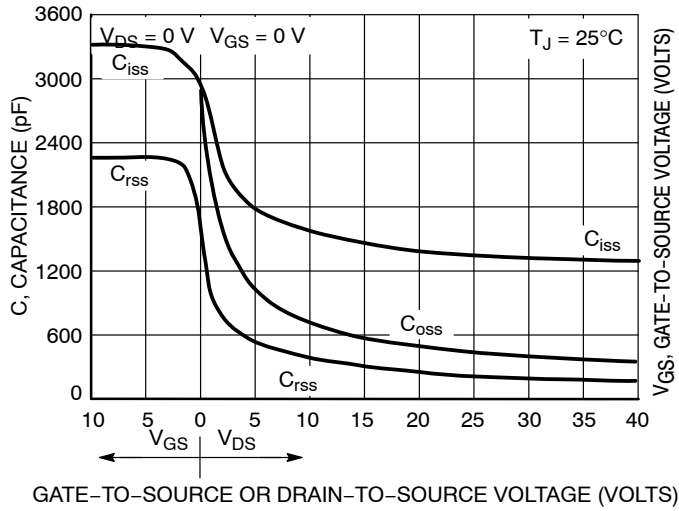

Figure 7. Capacitance Variation

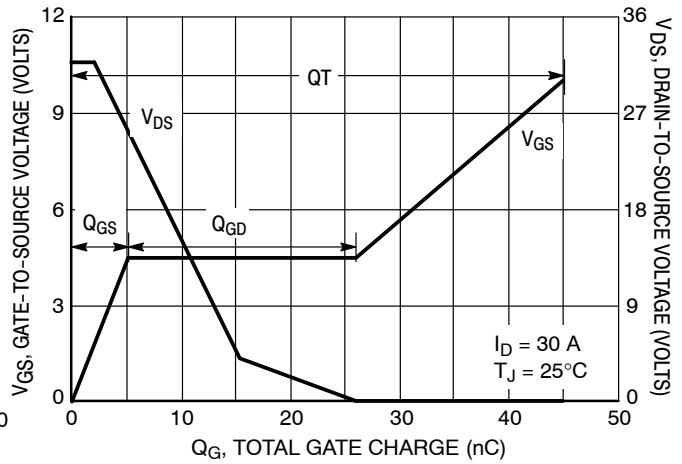

Figure 8. Gate-To-Source and Drain-To-Source Voltage vs. Total Charge

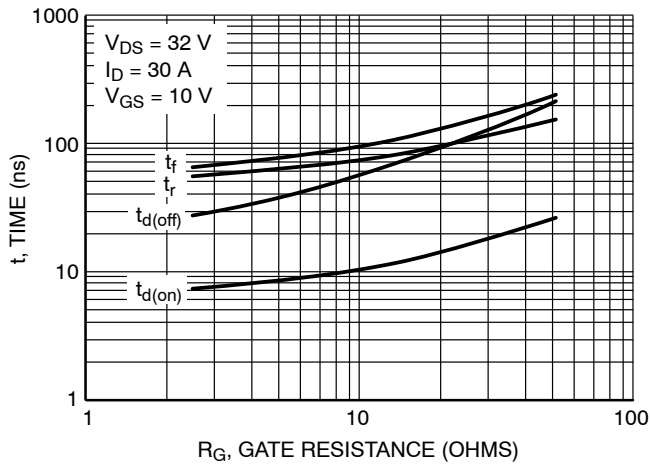

Figure 9. Resistive Switching Time Variation vs. Gate Resistance

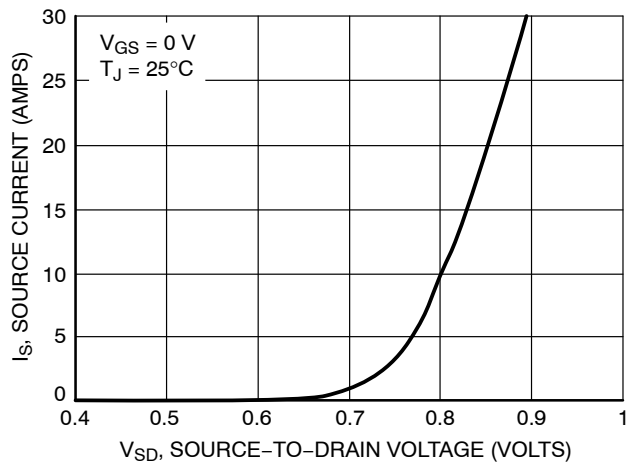
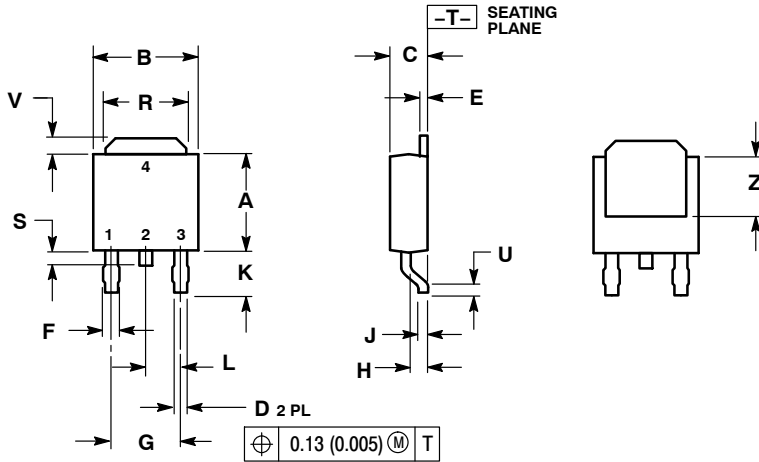

Figure 10. Diode Forward Voltage vs. Current

NTD5406N

PACKAGE DIMENSIONS

DPAK CASE 369C-01 ISSUE B



- NOTES:
1. DIMENSIONING AND TOLERANCING PER ANSI Y14.5M, 1982.
2. CONTROLLING DIMENSION: INCH.

DIM	INCHES		MILLIMETERS	
	MIN	MAX	MIN	MAX
A	0.235	0.245	5.97	6.22
B	0.250	0.265	6.35	6.73
C	0.086	0.094	2.19	2.38
D	0.027	0.035	0.69	0.88
E	0.018	0.023	0.46	0.58
F	0.037	0.045	0.94	1.14
G	0.180 BSC		4.58 BSC	
H	0.034	0.040	0.87	1.01
J	0.018	0.023	0.46	0.58
K	0.102	0.114	2.60	2.89
L	0.090 BSC		2.29 BSC	
R	0.180	0.215	4.57	5.45
S	0.025	0.040	0.63	1.01
U	0.020	---	0.51	---
V	0.035	0.050	0.89	1.27
Z	0.155	---	3.93	---

- STYLE 2:
PIN 1. GATE
2. DRAIN
3. SOURCE
4. DRAIN

SOLDERING FOOTPRINT*

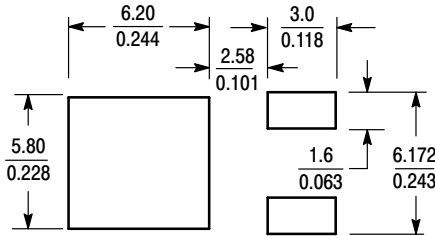

SCALE 3:1 (mm/inches)

*For additional information on our Pb-Free strategy and soldering details, please download the ON Semiconductor Soldering and Mounting Techniques Reference Manual, SOLDERRM/D.

ON Semiconductor and are registered trademarks of Semiconductor Components Industries, LLC (SCILLC). SCILLC reserves the right to make changes without further notice to any products herein. SCILLC makes no warranty, representation or guarantee regarding the suitability of its products for any particular purpose, nor does SCILLC assume any liability arising out of the application or use of any product or circuit, and specifically disclaims any and all liability, including without limitation special, consequential or incidental damages. "Typical" parameters which may be provided in SCILLC data sheets and/or specifications can and do vary in different applications and actual performance may vary over time. All operating parameters, including "Typicals" must be validated for each customer application by customer's technical experts. SCILLC does not convey any license under its patent rights nor the rights of others. SCILLC products are not designed, intended, or authorized for use as components in systems intended for surgical implant into the body, or other applications intended to support or sustain life, or for any other application in which the failure of the SCILLC product could create a situation where personal injury or death may occur. Should Buyer purchase or use SCILLC products for any such unintended or unauthorized application, Buyer shall indemnify and hold SCILLC and its officers, employees, subsidiaries, affiliates, and distributors harmless against all claims, costs, damages, and expenses, and reasonable attorney fees arising out of, directly or indirectly, any claim of personal injury or death associated with such unintended or unauthorized use, even if such claim alleges that SCILLC was negligent regarding the design or manufacture of the part. SCILLC is an Equal Opportunity/Affirmative Action Employer. This literature is subject to all applicable copyright laws and is not for resale in any manner.

PUBLICATION ORDERING INFORMATION

LITERATURE FULFILLMENT:
Literature Distribution Center for ON Semiconductor
P.O. Box 5163, Denver, Colorado 80217 USA
Phone: 303-675-2175 or 800-344-3860 Toll Free USA/Canada
Fax: 303-675-2176 or 800-344-3867 Toll Free USA/Canada
Email: orderlit@onsemi.com

N. American Technical Support: 800-282-9855 Toll Free USA/Canada
Europe, Middle East and Africa Technical Support:
Phone: 421 33 790 2910
Japan Customer Focus Center
Phone: 81-3-5773-3850

ON Semiconductor Website: www.onsemi.com
Order Literature: <http://www.onsemi.com/orderlit>
For additional information, please contact your local Sales Representative